



E9\*10R05/01\*16969\*00

Página / Page 1 / 3

Comunicación relativa a la / *Communication concerning to*

- homologación / *approval granted* <sup>(1)</sup>
- denegación de homologación / *approval refused* <sup>(1)</sup>
- extensión de homologación / *approval extended* <sup>(1)</sup>
- retirada de homologación / *approval withdrawn* <sup>(1)</sup>
- cese definitivo de homologación / *production definitely discontinued* <sup>(1)</sup>

de un tipo de subconjunto eléctrico/electrónico <sup>(1)</sup>, en aplicación del Reglamento nº 10.05/  
*of a type of electrical/electronic sub-assembly* <sup>(1)</sup> with regard to ECE Regulation No. 10.05.

Nº de homologación/ *Approval No.*: E9\*10R05/01\*16969\*00

Extensión Nº / *Extension No.*: 00

1. Marca (razón social)/ *Make (trade name of manufacturer)*: VISION X o/or HAMMERHEAD o/or CF MOTO o/or OEX o/or CRX o/or ROADVISION o/or DURAVISION o/or PROLIGHT o/or NIGHTBREAKER o/or GENER8 o/or DULITE o/or SUPERVISION o/or SATURN o/or POLARIS o/or MAX LIGHT o/or GREAT WHITE o/or TWISTED THROTTLE o/or DENALI o/or THUNDER o/or TUSCANY o/or HIVIZ o/or BROW LIGHT o/or FIRETECH o/or INVINCIBLE o/or CUSTOM DYNAMICS o/or CD
2. Tipo y denominación(es) comercial (es)/ *Type and general commercial description(s)*: XPR-H6 / XPR SERIES  
  
*Variant/ variant(s)*: Ver documentación técnica / *See technical documentation*
3. Medio de identificación del tipo, si está marcado en el vehículo, el componente o la unidad técnica independiente <sup>(1)</sup> / *Means of identification of type, if marked on the vehicle/component/separate technical unit* <sup>(1)</sup>: Ver documentación técnica / *See technical documentation*
- 3.1. Emplazamiento de estas marcas/ *Location of that marking*: Ver documentación técnica / *See technical documentation*
4. Categoría del vehículo / *Category of the vehicle*: ----
5. Nombre y dirección del fabricante/ *Name and address of manufacturer*:  
VISION X ASIA Co., Ltd.  
23-7, Dongtansandan 9-gil, Dongtan-myeon, Hwaseong-si, Gyeonggi-do , Korea
6. En el caso de componentes y entidades técnicas, situación y sistema de fijación de la marca de homologación / *In the case of components and separate technical units, location and method of affixing of the approval mark*:  
Ver documentación técnica / *See technical documentation*
7. Dirección (es) de la planta(s) de montaje/ *Address(es) of assembly plant(s)*:  
VISION X ASIA Co., Ltd.  
23-7, Dongtansandan 9-gil, Dongtan-myeon, Hwaseong-si, Gyeonggi-do , Korea

(1) Tachar lo que no proceda / *Strike out what does not apply*



E9\*10R05/01\*16969\*00

Página / Page 2 / 3

8. Información complementaria (si procede)/*Additional information(when applicable):*  
Vease apéndice / *See appendix*
9. Servicio técnico encargado de la realización de los ensayos/ *Technical service responsible for carrying out the tests:* IDIADA
10. Fecha del acta de ensayo/ *Date of test report:* 15/10/2019
11. Número del acta de ensayo/ *Number of test report:* KR19100101
12. Observaciones (si las hubiera)/*Remarks (if any):* Vease apéndice / *See appendix*
13. Lugar / *Place:* Madrid
14. Fecha / *Date:* Ver firma electrónica / *See digital signature*
15. EL SUBDIRECTOR GENERAL DE CALIDAD Y SEGURIDAD INDUSTRIAL.  
Resolución P.D. del DIRECTOR GENERAL DE INDUSTRIA Y DE LA PYME de 25-10-2012
16. Se adjunta el índice del expediente de homologación en posesión de las autoridades competentes y que puede obtenerse a petición del interesado./ *The index to the information package lodged with the approval authority, which may be obtained on request is attached.*
17. Motivos de extensión/ *Reasons for extension:* ----



E9\*10R05/01\*16969\*00

Página / Page 3 / 3

**Apéndice del certificado de homologación N° E9\*10R05/01\*16969\*00  
relativo a la homologación de subconjuntos eléctricos o electrónicos en lo que se refiere al Reglamento N°10**

***Appendix to Type-approval communication form N° E9\*10R05/01\*16969\*00  
concerning the type-approval of an electrical/electronic sub-assembly under Regulation N° 10.***

1. Información complementaria (si procede) / *Additional information (where applicable):*
  - 1.1. Tensión nominal del sistema eléctrico: DC 12V y DC 24V negativo tierra.  
*Electrical system rated voltage: DC 12V and DC 24V negative ground.*
  - 1.2. Este SEE puede utilizarse en cualquier tipo de vehículo con las restricciones siguientes / *This ESA can be used on any vehicle type with the following restrictions: Sí / Yes*
    - 1.2.1 Condiciones de instalación, si procede/ *Installation conditions, if any:* Ver documentación técnica / *See technical documentation*
    - 1.3. Este SEE solamente puede utilizarse en los tipos de vehículos siguientes / *This ESA can be used only on the following vehicle types:* No aplicable / *Not applicable*
      - 1.3.1 Condiciones de instalación, si procede/ *Installation conditions, if any:* No aplicable / *Not applicable*
    - 1.4. El(los) método(s) específico(s) de ensayo(s) y las bandas de frecuencias cubiertas para determinar la inmunidad es(son): (indicar el método utilizado del anexo 9)/ *The specific test method(s) used and the frequency ranges covered to determine immunity were: (Please specify precise method used from annex 9):* Ver informe de ensayo / *See test report*
    - 1.5. Laboratorio acreditado según ISO 17025 y reconocido por el organismo homologador responsable de realizar los ensayos/ *Laboratory accredited to ISO 17025 and recognized by the Approval Authority responsible for carrying out the tests:* IDIADA
  2. Observaciones (si las hubiera)/*Remarks (if any):* ----

(1) Táchese lo que no proceda / *Delete where not applicable*

**INFORME / REPORT N° KR19100101****REGLAMENTO 10.05/ECE RELATIVO A LA COMPATIBILIDAD ELECTROMAGNETICA  
REGULATION 10.05/ECE RELATING TO ELECTROMAGNETIC COMPATIBILITY**

Solicitante / <i>Applicant</i>	: VISION X ASIA Co., Ltd.
Fabricante del vehículo / <i>Manufacturer</i>	: VISION X ASIA Co., Ltd. 23-7, Dongtansandan 9-gil, Dongtan-myeon, Hwaseong-si, Gyeonggi-do , Korea
Marca / <i>Mark</i>	: VISION X o/or HAMMERHEAD o/or CF MOTO o/or OEX o/or CRX o/or ROADVISION o/or DURAVISION o/or PROLIGHT o/or NIGHTBREAKER o/or GENER8 o/or DULITE o/or SUPERVISION o/or SATURN o/or POLARIS o/or MAX LIGHT o/or GREAT WHITE o/or TWISTED THROTTLE o/or DENALI o/or THUNDER o/or TUSCANY o/or HIVIZ o/or BROW LIGHT o/or FIRETECH o/or INVINCIBLE o/or CUSTOM DYNAMICS o/or CD
Tipo / <i>Type</i>	: XPR-H6
Denominación comercial / <i>Commercial description</i>	: XPR SERIES
Variante / <i>Variant</i>	: Ver documentación técnica / <i>See technical documentation</i>
Categoría / <i>Category</i>	: Componente / <i>Component</i>
Lugar y fecha de emisión del informe / <i>Place and date of issue</i>	: L'Albornar, Santa Oliva (Tarragona-SPAIN) 15/10/2019

CONCLUSIONES / *CONCLUSIONS*: El subconjunto electrónico o eléctrico presentado CUMPLE las prescripciones relativas a la compatibilidad electromagnética en aplicación del Reglamento 10.05/ECE, según se detalla en el anexo a este informe./ *This ESA FULFILLS the prescriptions about electromagnetic compatibility in application to Regulation 10.05/ECE, as detailed in annex to this report.*

Realizado / *Performed by*:Kidong Lee  
INGENIERO DE HOMOLOGACIONES  
HOMOLOGATION ENGINEERV. B°./ *Revised by*:Lluís Sans Gomis  
JEFE DE DEPARTAMENTO  
DEPARTMENT MANAGER

\* LOS RESULTADOS PRESENTADOS SE REFIEREN UNICAMENTE A LA MUESTRA ENSAYADA.  
*THE PRESENTED RESULTS REFER ONLY TO THE TESTED SAMPLE*

\* QUEDA TERMINANTEMENTE PROHIBIDA LA REPRODUCCION PARCIAL DE ESTE INFORME SIN PERMISO EXPRESO DE IDIADA.  
*THE PARTIAL REPRODUCTION OF THIS REPORT WITHOUT THE PERMISSION OF IDIADA IS COMPLETELY FORBIDDEN*



**ANEXO AL INFORME /  
ANNEX TO THE REPORT**

1. CARACTERISTICAS DEL COMPONENTE ENSAYADO /  
TESTED COMPONENT CHARACTERISTICS

Marca / Trade name	: VISION X o/or HAMMERHEAD o/or CF MOTO o/or OEX o/or CRX o/or ROADVISION o/or DURAVISION o/or PROLIGHT o/or NIGHTBREAKER o/or GENER8 o/or DULITE o/or SUPERVISION o/or SATURN o/or POLARIS o/or MAX LIGHT o/or GREAT WHITE o/or TWISTED THROTTLE o/or DENALI o/or THUNDER o/or TUSCANY o/or HIVIZ o/or BROW LIGHT o/or FIRETECH o/or INVINCIBLE o/or CUSTOM DYNAMICS o/or CD
Tipo / Type	: XPR-H6
Denominación comercial / Commercial description	: XPR SERIES
Función / Function	: Barra de luz LED/ LED bar light
Voltaje /Rated voltage	: DC 12V y/and DC 24V
Oscilador electrónico de frecuencia superior a 9kHz / Electronic oscillator with frequency greater than 9 kHz	: SI / YES
Número de identificación de la muestra / Sample identification No.	: KR19100101
Fecha de recepción de la muestra / Sample received on	: 16/09/2019

Validate this report with the security code «HVFGRYXV» at: <https://extranet.idiada.com/hom-cve>  
 Verifique el informe con código de seguridad «HVFGRYXV» en: <https://extranet.idiada.com/hom-cve>

KR19100101



\* LOS RESULTADOS PRESENTADOS SE REFIEREN UNICAMENTE A LA MUESTRA ENSAYADA.  
THE PRESENTED RESULTS REFER ONLY TO THE TESTED SAMPLE

\* QUEDA TERMINANTEMENTE PROHIBIDA LA REPRODUCCION PARCIAL DE ESTE INFORME SIN PERMISO EXPRESO DE IDIADA.  
THE PARTIAL REPRODUCTION OF THIS REPORT WITHOUT THE PERMISSION OF IDIADA IS COMPLETELY FORBIDDEN



2. ENSAYO DE RADIACION ELECTROMAGNETICA  
ELECTROMAGNETIC RADITION TEST

2.1. Ensayo de radiación electromagnética de banda ancha /  
*Broadband electromagnetic radiation test*

Método de ensayo / <i>Test method</i>	: Indoor / <del>Outdoor</del>
Condiciones del lugar de ensayo / <i>Test place conditions</i>	: Según el apéndice 2 del anexo 7 / <i>According to Appendix 2 of the Annex 7</i>
Detectores de la antena receptora / <i>Receiving antenna detectors</i>	: <del>Cresta</del> / Quasi-cresta <i>Peak / Quasi peak</i>
Componente en estado normal de funcionamiento <i>Component at normal operating</i>	: SI / YES
Voltaje / <i>Rated voltage</i>	: DC 12V y/and DC 24V
Ancho de banda / <i>Bandwidth</i>	: 120kHz

2.2. Ensayo de radiación electromagnética de banda estrecha /  
*Narrowband electromagnetic radiation test*

Método de ensayo / <i>Test method</i>	: Indoor / <del>Outdoor</del>
Condiciones del lugar de ensayo / <i>Test place conditions</i>	: Según el anexo 8 / <i>According to the Annex 8</i>
Detectores de la antena receptora / <i>Receiving antenna detectors</i>	: <del>Cresta</del> / Media <i>Peak / Average</i>
Componente en estado normal de funcionamiento <i>Component at normal operating</i>	: SI / YES
Voltaje / <i>Rated voltage</i>	: DC 12V y/and DC 24V
Ancho de banda / <i>Bandwidth</i>	: 120 kHz

Validate this report with the security code «HVFGRYXV» at: <https://extranet.idiada.com/hom-cve>  
 Verifique el informe con código de seguridad «HVFGRYXV» en: <https://extranet.idiada.com/hom-cve>

KR19100101



\* LOS RESULTADOS PRESENTADOS SE REFIEREN UNICAMENTE A LA MUESTRA ENSAYADA.  
 THE PRESENTED RESULTS REFER ONLY TO THE TESTED SAMPLE

\* QUEDA TERMINANTEMENTE PROHIBIDA LA REPRODUCCION PARCIAL DE ESTE INFORME SIN PERMISO EXPRESO DE IDIADA.  
 THE PARTIAL REPRODUCTION OF THIS REPORT WITHOUT THE PERMISSION OF IDIADA IS COMPLETELY FORBIDDEN



Resultados de ensayo con 12V / Test results with 12V:

Horizontal / Horizontal

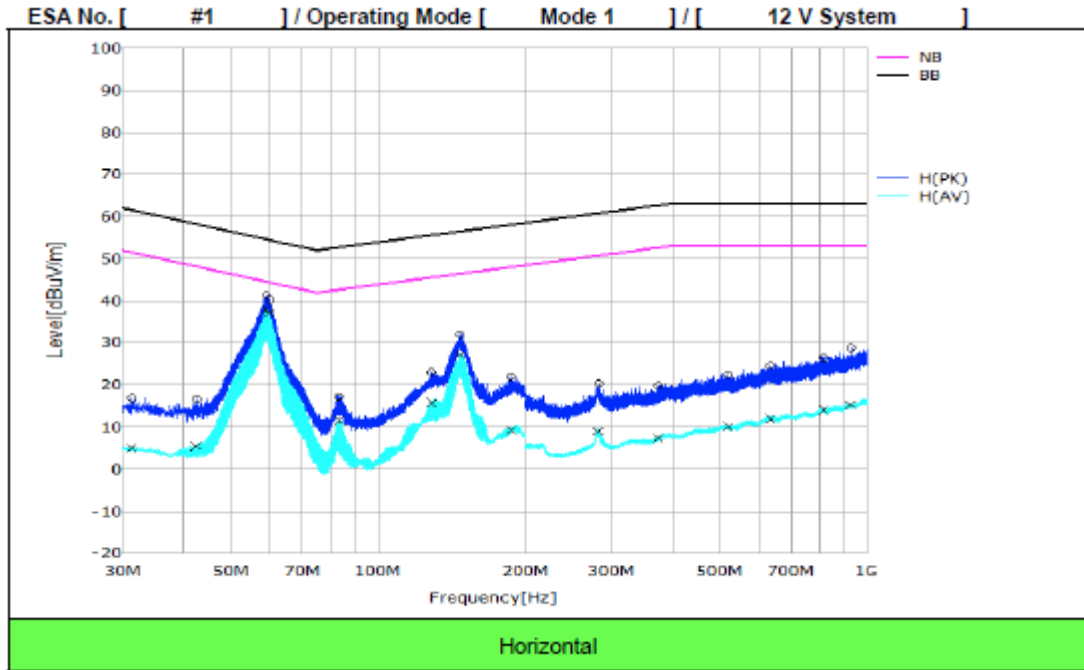

Vertical / Vertical

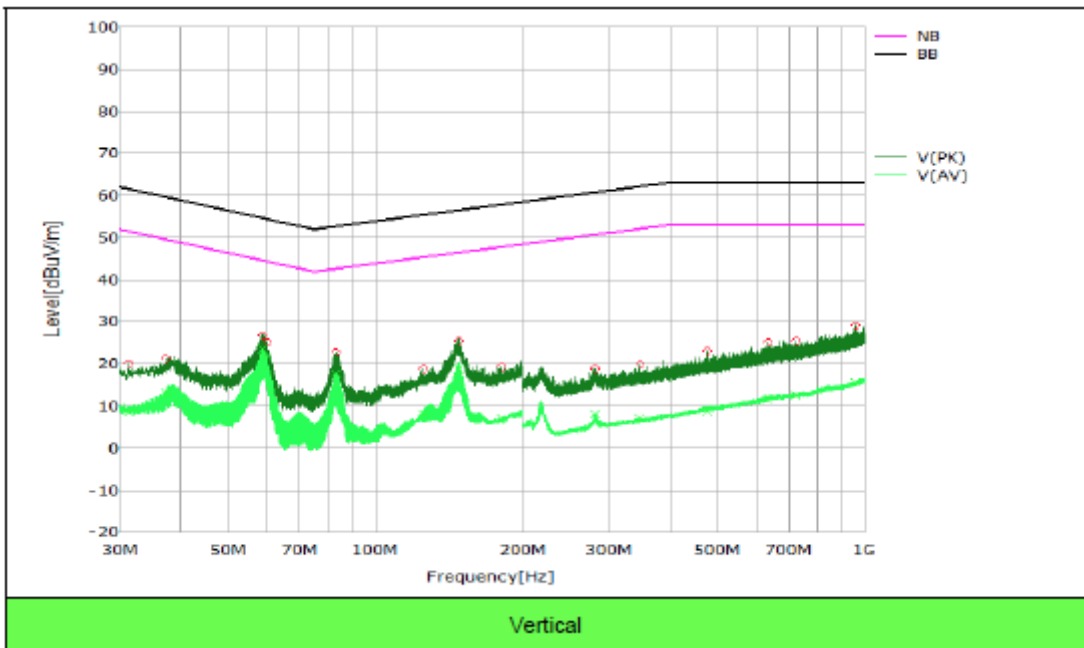

(\* Se considera que el SEE cumple los requisitos respecto a esta banda de frecuencias en aplicación del punto 6.5.2.2. y 6.6.2.2. del Reglamento 10.05/CEC /The ESA is deemed to conform to the requirements in respect of this frequency band according to 6.5.2.2 and 6.6.2.2. of Regulation 10.05/ECE

**CORRECT / NOT CORRECT**

\* LOS RESULTADOS PRESENTADOS SE REFIEREN UNICAMENTE A LA MUESTRA ENSAYADA.

THE PRESENTED RESULTS REFER ONLY TO THE TESTED SAMPLE

\* QUEDA TERMINANTEMENTE PROHIBIDA LA REPRODUCCION PARCIAL DE ESTE INFORME SIN PERMISO EXPRESO DE IDIADA.

THE PARTIAL REPRODUCTION OF THIS REPORT WITHOUT THE PERMISSION OF IDIADA IS COMPLETELY FORBIDDEN



Resultados de ensayo con 24V / Test results with 24V:

Horizontal / Horizontal

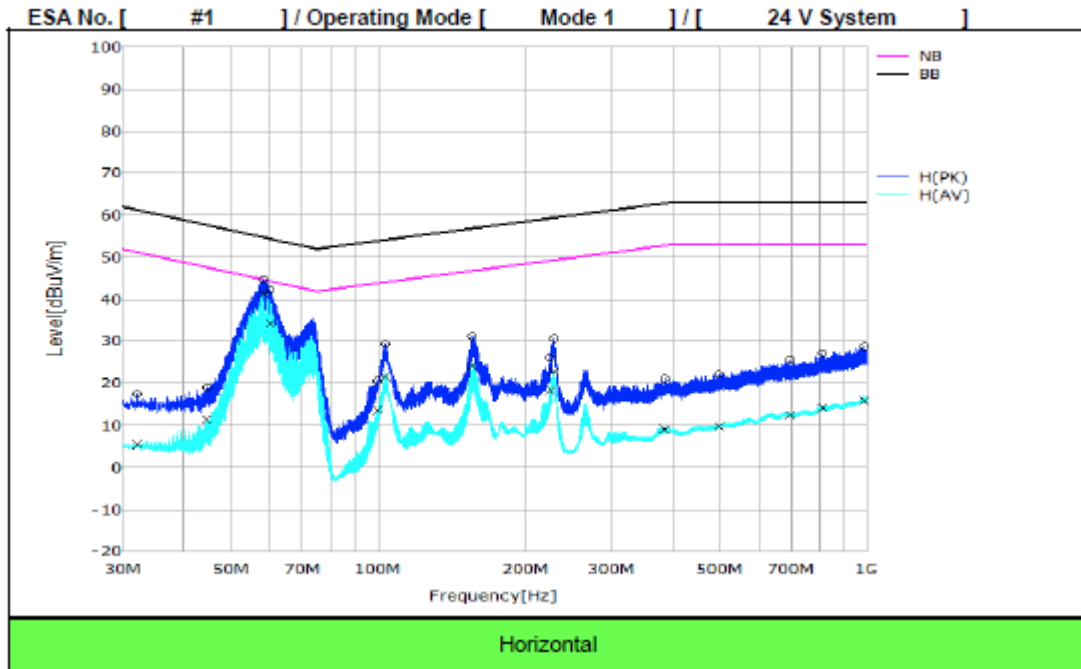

Vertical / Vertical

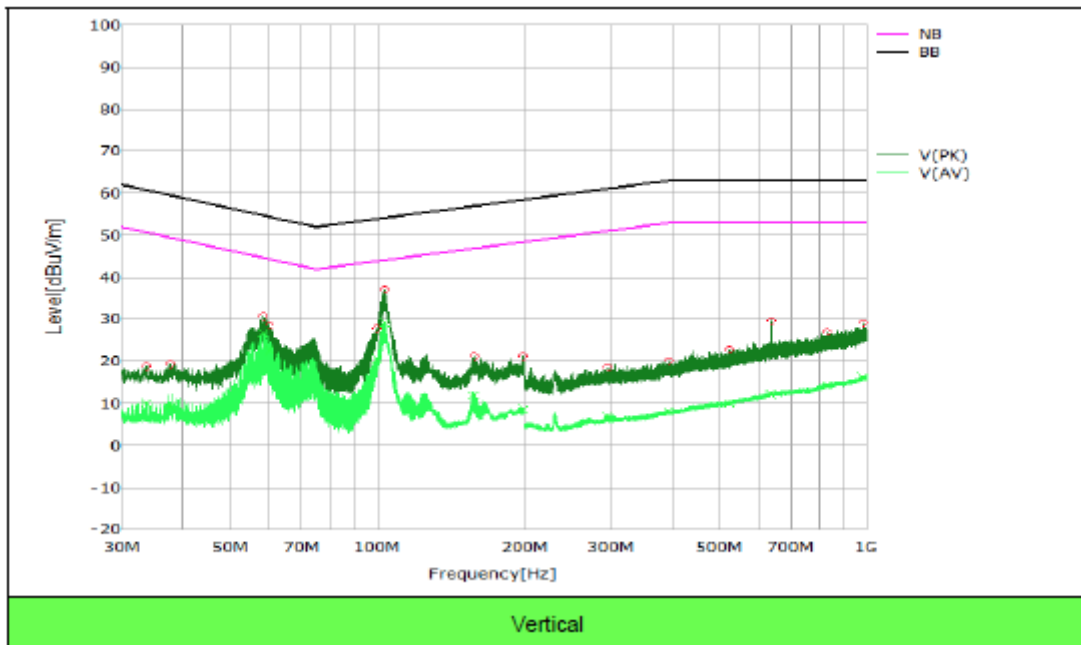

(\* Se considera que el SEE cumple los requisitos respecto a esta banda de frecuencias en aplicación del punto 6.5.2.2. y 6.6.2.2. del Reglamento 10.05/CEC /The ESA is deemed to conform to the requirements in respect of this frequency band according to 6.5.2.2 and 6.6.2.2. of Regulation 10.05/ECE

**CORRECT / NOT CORRECT**

\* LOS RESULTADOS PRESENTADOS SE REFIEREN UNICAMENTE A LA MUESTRA ENSAYADA.  
 THE PRESENTED RESULTS REFER ONLY TO THE TESTED SAMPLE  
 \* QUEDA TERMINANTEMENTE PROHIBIDA LA REPRODUCCION PARCIAL DE ESTE INFORME SIN PERMISO EXPRESO DE IDIADA.  
 THE PARTIAL REPRODUCTION OF THIS REPORT WITHOUT THE PERMISSION OF IDIADA IS COMPLETELY FORBIDDEN  
 IDIADA Automotive Technology, S.A. N.I.F. A43581610





3. ENSAYO DE INMUNIDAD ELECTROMAGNETICA  
ELECTROMAGNETIC IMMUNITY TEST

Lugar de ensayo / Test site: DT&C (Korea)

Requisitos de ensayo / Test requirements

Frequency steps sizes		Severity level (IV) (mA)	Injection probe position (mm)	Dwell time (s)	Modulation
Frequency band (MHz)	Linear steps (MHz)				
20 to 80	5	60	150	2	AM (80 %, 1 kHz)

Frequency steps sizes		Severity level (IV) (V/m)	Antenna polarization	Dwell time (s)	Modulation
Frequency band (MHz)	Linear steps (MHz)				
80 to 200	5	30	Vertical	2	AM (80 %, 1 kHz)
200 to 400	10		Vertical	2	AM (80 %, 1 kHz)
400 to 800	20		Vertical	2	AM (80 %, 1 kHz)
800 to 1 000	20		Vertical	2	PM (PRR 217 Hz, PD 577 µs)
1 000 to 2000	40		Vertical	2	PM (PRR 217 Hz, PD 577 µs)

Validate this report with the security code «HVFGYXV» at: <https://extranet.idiada.com/hom-cve>  
 Verifique el informe con código de seguridad «HVFGYXV» en: <https://extranet.idiada.com/hom-cve>

KR19100101



\* LOS RESULTADOS PRESENTADOS SE REFIEREN UNICAMENTE A LA MUESTRA ENSAYADA.  
*THE PRESENTED RESULTS REFER ONLY TO THE TESTED SAMPLE*

\* QUEDA TERMINANTEMENTE PROHIBIDA LA REPRODUCCION PARCIAL DE ESTE INFORME SIN PERMISO EXPRESO DE IDIADA.  
*THE PARTIAL REPRODUCTION OF THIS REPORT WITHOUT THE PERMISSION OF IDIADA IS COMPLETELY FORBIDDEN*



Ensayo en cámara de absorción / Absorber Chamber Test Results

ESA No. [ #1 ] / Operating Mode [ Mode 1 ] / [ 12 V System ]				
Frequency (MHz)	Antenna polarization	Modulation	Deviation	FPSC
80 to 800	Vertical	AM	No deviations detected	Class A
800 to 2 000		PM	No deviations detected	Class A

Spot Frequency (MHz)	Antenna polarization	Modulation	Deviation	FPSC
90, 120, 150, 190, 230, 280, 380, 450, 600, 750	Vertical	AM	No deviations detected	Class A
900, 1 300, 1 800		PM	No deviations detected	Class A

ESA No. [ #1 ] / Operating Mode [ Mode 1 ] / [ 24 V System ]				
Frequency (MHz)	Antenna polarization	Modulation	Deviation	FPSC
80 to 800	Vertical	AM	No deviations detected	Class A
800 to 2 000		PM	No deviations detected	Class A

Spot Frequency (MHz)	Antenna polarization	Modulation	Deviation	FPSC
90, 120, 150, 190, 230, 280, 380, 450, 600, 750	Vertical	AM	No deviations detected	Class A
900, 1 300, 1 800		PM	No deviations detected	Class A

Validate this report with the security code «HVFGRYXV» at: <https://extranet.idiada.com/hom-cve>  
 Verifique el informe con código de seguridad «HVFGRYXV» en: <https://extranet.idiada.com/hom-cve>

**IDIADA** KR19100101

\* LOS RESULTADOS PRESENTADOS SE REFIEREN UNICAMENTE A LA MUESTRA ENSAYADA.  
 THE PRESENTED RESULTS REFER ONLY TO THE TESTED SAMPLE

\* QUEDA TERMINANTEMENTE PROHIBIDA LA REPRODUCCION PARCIAL DE ESTE INFORME SIN PERMISO EXPRESO DE IDIADA.  
 THE PARTIAL REPRODUCTION OF THIS REPORT WITHOUT THE PERMISSION OF IDIADA IS COMPLETELY FORBIDDEN

IDIADA Automotive Technology, S.A. N.I.F. A43581610



Ensayo de aplicación de pulsos de corriente / *Bulk Current Injection Test Results*

ESA No. [ #1 ] / Operating Mode [ Mode 1 ] / [ 12 V System ]				
Frequency (MHz)	Injection probe position (mm)	Modulation	Deviation	FPSC
20 to 80	150	AM	No deviations detected	Class A

Spot Frequency (MHz)	Injection probe position (mm)	Modulation	Deviation	FPSC
27, 45, 65	150	AM	No deviations detected	Class A

ESA No. [ #1 ] / Operating Mode [ Mode 1 ] / [ 24 V System ]				
Frequency (MHz)	Injection probe position (mm)	Modulation	Deviation	FPSC
20 to 80	150	AM	No deviations detected	Class A

Spot Frequency (MHz)	Injection probe position (mm)	Modulation	Deviation	FPSC
27, 45, 65	150	AM	No deviations detected	Class A

Validate this report with the security code «HVFGRYXV» at: <https://extranet.idiada.com/hom-cve>  
 Verifique el informe con código de seguridad «HVFGRYXV» en: <https://extranet.idiada.com/hom-cve>

KR19100101



\* LOS RESULTADOS PRESENTADOS SE REFIEREN UNICAMENTE A LA MUESTRA ENSAYADA.

*THE PRESENTED RESULTS REFER ONLY TO THE TESTED SAMPLE*

\* QUEDA TERMINANTEMENTE PROHIBIDA LA REPRODUCCION PARCIAL DE ESTE INFORME SIN PERMISO EXPRESO DE IDIADA.

*THE PARTIAL REPRODUCTION OF THIS REPORT WITHOUT THE PERMISSION OF IDIADA IS COMPLETELY FORBIDDEN*



4. INMUNIDAD Y EMISIONES DE PERTURBACIONES CONDUCCIDAS / IMMUNITY AND EMISSION OF CONDUCTED DISTURBANCES

4.1. Inmunidad a las perturbaciones transitorias conducidas a lo largo de las líneas de alimentación / *Immunity against disturbances conducted along supply lines*

Método de ensayo / *Test method* : R10.05/ECE; Según ISO 7637-2:2004  
R10.05/ECE; According ISO 7637-2:2004

Estado de funcionamiento para el sistema/  
*Performance criteria* :

Pulso/ <i>Pulse</i>	Nivel de inmunidad/ <i>Immunity level</i>	Estado de funcionamiento para el sistema/ <i>Performance criteria</i>	
		Relacionados con funciones de inmunidad/ <i>Related to immunity functions</i>	No relacionados con funciones de inmunidad/ <i>Not related to immunity functions</i>
1	III	C	⊘
2a	III	B	⊘
2b	III	C	⊘
3a/3b	III	A	⊘
4	III	B o/ or C B (para SEE que deberán estar operativos durante las fases de arranque del motor) C (para otros SEE) <i>B (for ESA which must be operational during engine start phases) C (for other ESA)</i>	⊘

The functional states of devices during the tests refer to the following :	
CLASS A	all functions of a device/system perform as designed during and after exposure to disturbance.
CLASS B	all functions of a device/system perform as designed during exposure. However, one or more of them can go beyond specified tolerance. All functions return automatically to within normal limits after exposure is removed. Memory functions shall remain class A.
CLASS C	one or more functions of a device/system do not perform as designed during exposure but return automatically to normal operation after exposure is removed.
CLASS D	one or more functions of a device/system do not perform as designed during exposure and do not return to normal operation until exposure is removed and the device/system is reset by simple "operator/use" action.
CLASS E	one or more functions of a device/system do not perform as designed during and after exposure and cannot be returned to proper operation without repairing or replacing the device/system.

Tensión de alimentación de ensayo/  
*Test Voltage* : DC 12V y/and DC 24V

\* LOS RESULTADOS PRESENTADOS SE REFIEREN UNICAMENTE A LA MUESTRA ENSAYADA.  
*THE PRESENTED RESULTS REFER ONLY TO THE TESTED SAMPLE*

\* QUEDA TERMINANTEMENTE PROHIBIDA LA REPRODUCCION PARCIAL DE ESTE INFORME SIN PERMISO EXPRESO DE IDIADA.  
*THE PARTIAL REPRODUCTION OF THIS REPORT WITHOUT THE PERMISSION OF IDIADA IS COMPLETELY FORBIDDEN*



Resultados de ensayo / *Test results:*

Sistema a 12V/ *12V system:*

Numero de Pulso / <i>Test pulse number</i>	Nivel III de Inmunidad / <i>Immunity Level III</i>	Condiciones del Pulso/ <i>Pulse Condition</i>	Min.Número de pulsos o tiempo/ <i>Min. Numbers of pulse or time</i>	Resultado de ensayo / <i>Test result</i>
1	-75V	Ri=10Ω, td=2ms, tr<1μs, t1=0.5s, t2=200ms, t3<100μs	5000 pulsos/ <i>pulses</i>	C
2 a	+37V	Ri=2Ω, td=50μs, tr<1μs, t1=0.2s	5000 pulsos/ <i>pulses</i>	A
2 b	+10V	Ri=0Ω, td=0.2s, t12=1ms, tr=1ms, t6=1ms	10 pulsos/ <i>pulses</i>	C
3 a	-112V	Ri=50Ω, td=0.1μs, tf<5ns, t1=100μs, t4=10ms, t5=90ms	1 hora/ <i>hour</i>	A
3 b	+75V	Ri=50Ω, td=0.1μs, tr<5ns, t1=100μs, t4=10ms, t5=90ms	1 hora/ <i>hour</i>	A
4	-6V	Va=-4V, Ri=0Ω, t7=40ms, t8<50ms, t9=10s, t10=5ms, t11=5ms	1 pulsos/ <i>pulses</i>	C

**CORRECTO / CORRECT**

**NO APLICABLE / NOT APPLICABLE**

Sistema a 24V/ *24V system:*

Numero de Pulso / <i>Test pulse number</i>	Nivel III de Inmunidad / <i>Immunity Level III</i>	Condiciones del Pulso/ <i>Pulse Condition</i>	Min.Número de pulsos o tiempo/ <i>Min. Numbers of pulse or time</i>	Resultado de ensayo / <i>Test result</i>
1	-450V	Ri=50Ω, td=1ms, tr=3μs, t1=1s, t2=200ms, t3<100ms	5000 pulsos/ <i>pulses</i>	C
2 a	+37V	Ri=2Ω, td=0.05ms, tr=1μs, t1=0.2s	5000 pulsos/ <i>pulses</i>	A
2 b	+20V	Ri=0Ω, td=200ms, tf=1ms, tr=1ms, t6=1ms	10 pulsos/ <i>pulses</i>	C
3 a	-150V	Ri=50Ω, td=0.1μs, tf=5ns, t1=100μs, t4=10ms, t5=90ms	1 hora/ <i>hour</i>	A
3 b	+150V	Ri=50Ω, td=0.1μs, tr=5ns, t1=100μs, t4=10ms, t5=90ms	1 hora/ <i>hour</i>	A
4	-12V	Va=-3V, Ri=0Ω, t8<50ms, t9=0.5s, t10=5ms, t11=10ms	1 pulsos/ <i>pulses</i>	A

**CORRECTO / CORRECT**

**NO APLICABLE / NOT APPLICABLE**

\* LOS RESULTADOS PRESENTADOS SE REFIEREN UNICAMENTE A LA MUESTRA ENSAYADA.

*THE PRESENTED RESULTS REFER ONLY TO THE TESTED SAMPLE*

\* QUEDA TERMINANTEMENTE PROHIBIDA LA REPRODUCCION PARCIAL DE ESTE INFORME SIN PERMISO EXPRESO DE IDIADA.

*THE PARTIAL REPRODUCTION OF THIS REPORT WITHOUT THE PERMISSION OF IDIADA IS COMPLETELY FORBIDDEN*



4.2. Emisiones de perturbaciones conducidas/ *Emission of conducted disturbances*

- Método de ensayo / *Test method* : R10.05/ECE; Según ISO 7637-2:2004  
*R10.05/ECE; According ISO 7637-2:2004*
- Condiciones de medida/ *Measuring Condition* : Comprobación de la emisión de transitorios producidos en el interruptor de ENC/DESC hacia las líneas de alimentación/  
*Check transient emission at switch ON/OFF in Power Source lines*
- Equipos de ensayo *Measurement Equipment* : Según ISO 7637-2:2004  
*According ISO 7637-2:2004*
- Resultados de ensayo / *Test results* : (Ver gráficos adjuntos /*Refer to data graph below*)

Sistema a 12V/ 12V system:

Polaridad de la Amplitud del pulso / <i>Polarity of pulse amplitude</i>	Amplitud máxima permitida para/ <i>Maximum allowed pulse amplitude for</i>	Tipo de Pulso/ <i>Type of pulse</i>	Resultado de ensayo / <i>Test result</i>
	Vehículo con sistema a 12V/ <i>Vehicles with 12V systems</i>		
POSITIVA / <i>POSITIVE</i>	+75	Lento / <i>Slow</i>	Cumple / <i>Complies</i>
		Rápido / <i>Fast</i>	Cumple / <i>Complies</i>
NEGATIVA / <i>NEGATIVE</i>	-100	Lento / <i>Slow</i>	Cumple / <i>Complies</i>
		Rápido / <i>Fast</i>	Cumple / <i>Complies</i>

**CORRECTO / CORRECT**

**NO APLICABLE / NOT APPLICABLE**

Sistema a 24V/ 24V system:

Polaridad de la Amplitud del pulso / <i>Polarity of pulse amplitude</i>	Amplitud máxima permitida para/ <i>Maximum allowed pulse amplitude for</i>	Tipo de Pulso/ <i>Type of pulse</i>	Resultado de ensayo / <i>Test result</i>
	Vehículo con sistema a 24V/ <i>Vehicles with 24V systems</i>		
POSITIVA / <i>POSITIVE</i>	+150	Lento / <i>Slow</i>	Cumple / <i>Complies</i>
		Rápido / <i>Fast</i>	Cumple / <i>Complies</i>
NEGATIVA / <i>NEGATIVE</i>	-450	Lento / <i>Slow</i>	Cumple / <i>Complies</i>
		Rápido / <i>Fast</i>	Cumple / <i>Complies</i>

**CORRECTO / CORRECT**

**NO APLICABLE / NOT APPLICABLE**

\* LOS RESULTADOS PRESENTADOS SE REFIEREN UNICAMENTE A LA MUESTRA ENSAYADA.

*THE PRESENTED RESULTS REFER ONLY TO THE TESTED SAMPLE*

\* QUEDA TERMINANTEMENTE PROHIBIDA LA REPRODUCCION PARCIAL DE ESTE INFORME SIN PERMISO EXPRESO DE IDIADA.

*THE PARTIAL REPRODUCTION OF THIS REPORT WITHOUT THE PERMISSION OF IDIADA IS COMPLETELY FORBIDDEN*



Gráficos de los transitorios/ *Transient data Graph*

DC 12V

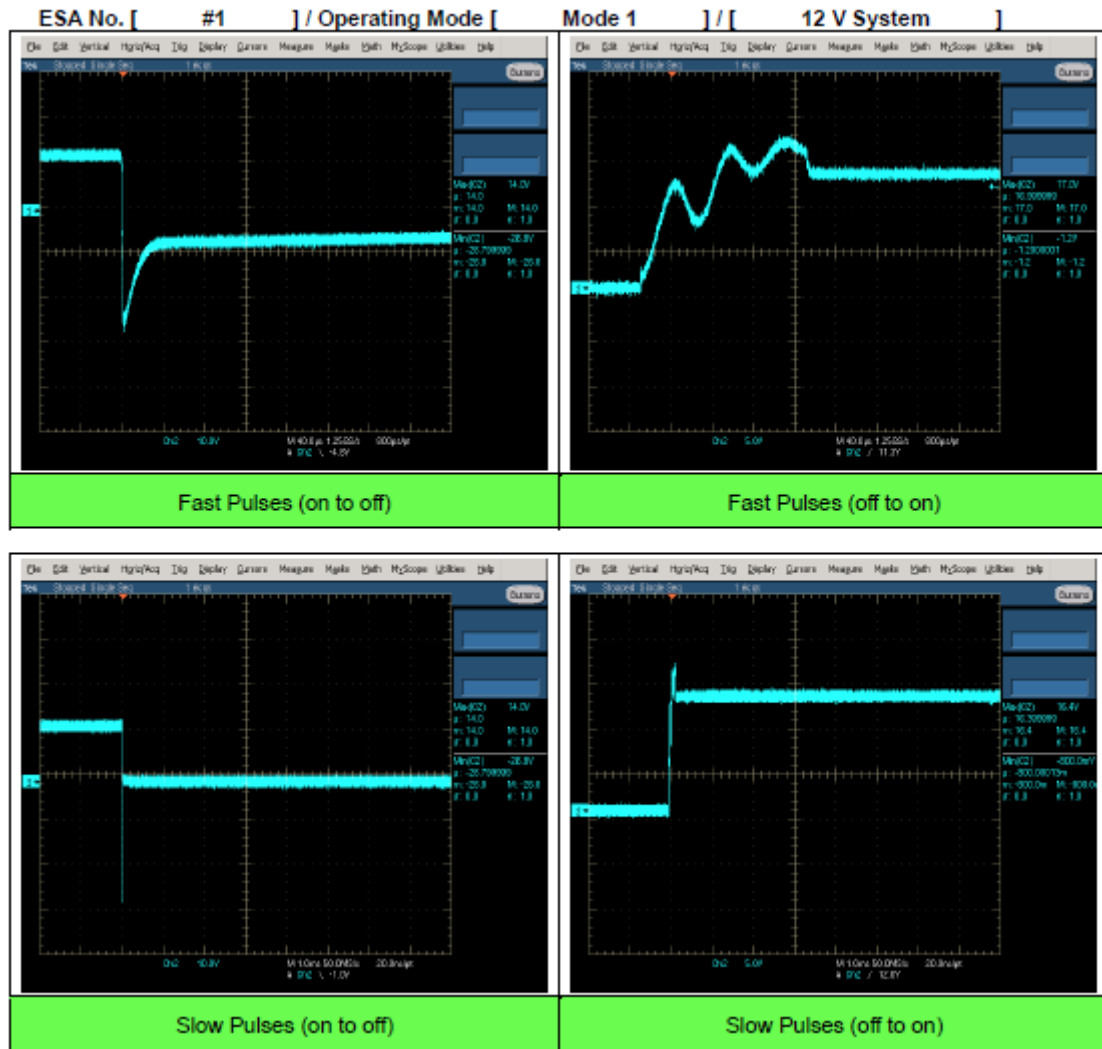

Validate this report with the security code «HVFGRYXV» at: <https://extranet.idiada.com/hom-cve>  
 Verifique el informe con código de seguridad «HVFGRYXV» en: <https://extranet.idiada.com/hom-cve>

KR19100101

IDIADA

\* LOS RESULTADOS PRESENTADOS SE REFIEREN UNICAMENTE A LA MUESTRA ENSAYADA.  
 THE PRESENTED RESULTS REFER ONLY TO THE TESTED SAMPLE  
 \* QUEDA TERMINANTEMENTE PROHIBIDA LA REPRODUCCION PARCIAL DE ESTE INFORME SIN PERMISO EXPRESO DE IDIADA.  
 THE PARTIAL REPRODUCTION OF THIS REPORT WITHOUT THE PERMISSION OF IDIADA IS COMPLETELY FORBIDDEN  
 IDIADA Automotive Technology, S.A. N.I.F. A43581610



DC 24V

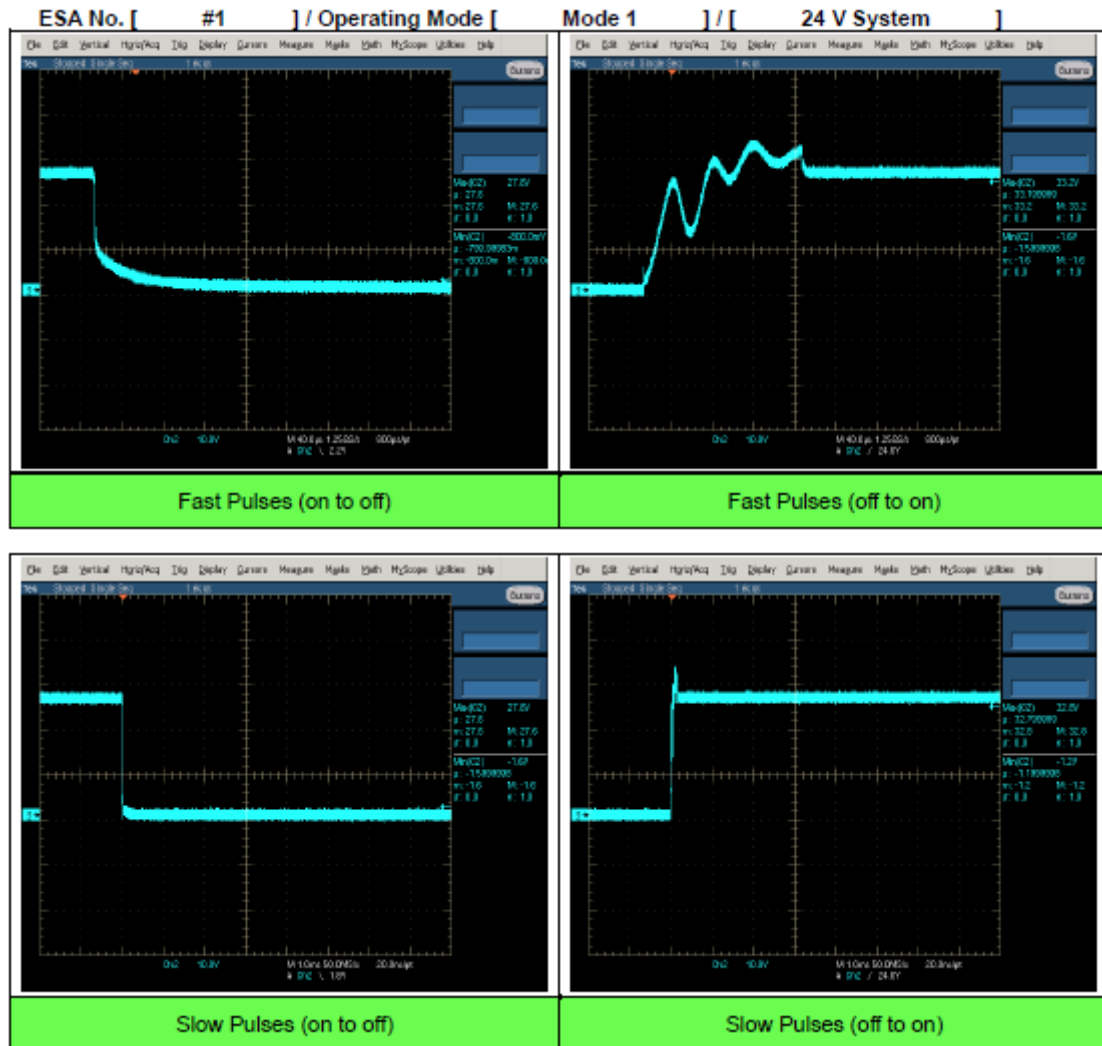

Validate this report with the security code «HVFGYXV» at: <https://extranet.idiada.com/hom-cve>  
 Verifique el informe con código de seguridad «HVFGYXV» en: <https://extranet.idiada.com/hom-cve>

IDIADA KR19100101

\* LOS RESULTADOS PRESENTADOS SE REFIEREN UNICAMENTE A LA MUESTRA ENSAYADA.  
 THE PRESENTED RESULTS REFER ONLY TO THE TESTED SAMPLE  
 \* QUEDA TERMINANTEMENTE PROHIBIDA LA REPRODUCCION PARCIAL DE ESTE INFORME SIN PERMISO EXPRESO DE IDIADA.  
 THE PARTIAL REPRODUCTION OF THIS REPORT WITHOUT THE PERMISSION OF IDIADA IS COMPLETELY FORBIDDEN  
 IDIADA Automotive Technology, S.A. N.I.F. A43581610





5. TEST EQUIPMENT/  
EQUIPOS DE ENSAYO

No.	Equipment Name	Model Name	Serial No.	Manufacturer	Cal. Date (yy/mm/dd)	Next Cal. Date (yy/mm/dd)
<b>Radiated Emission</b>						
1	EMI Test Receiver	ESW 8	100959	Rohde & Schwarz	18/10/16	19/10/16
2	Biconical Antenna	VHA 9103	8032	Schwarzbeck	18/09/17	20/09/17
3	Log-Periodic Antenna	VULP 9118A	627	Schwarzbeck	18/09/13	20/09/13
4	LISN	NNBM8124	114	Schwarzbeck	18/10/15	19/10/15
5	LISN	NNBM8124	115	Schwarzbeck	18/10/15	19/10/15
6	Pre- Amplifier	TK-PA06S	150085-L	TESTEK	18/12/04	19/12/04
<b>Conducted Transient Emission</b>						
1	Single Line Artificial Network	AN 2050N	0511-02	EM TEST	18/12/28	19/12/28
2	Electronic Switch	BS 200N100	P1646187526	EM TEST	N/A	N/A
3	Shunt resistor box	RS-BOX	P1629182020	EM TEST	N/A	N/A
4	High voltage probe	P5100A	NSN1774344A	Tektronix	18/12/05	19/12/05
5	Digital Phosphor Oscilloscope	TDS5104B	B010878	Tektronix	19/08/23	20/08/23
<b>Conducted Transient Immunity</b>						
1	Ultra Compact Simulator	UCS 200 N50	P1844224128	EM TEST	19/07/04	20/07/04
2	Voltage Drop Simulator	VDS200Q	P1910227627	EM TEST	19/07/04	20/07/04

Validate this report with the security code «HVFGYXV» at: <https://extranet.idiada.com/hom-cve>  
 Verifique el informe con código de seguridad «HVFGYXV» en: <https://extranet.idiada.com/hom-cve>

KR19100101



\* LOS RESULTADOS PRESENTADOS SE REFIEREN UNICAMENTE A LA MUESTRA ENSAYADA.

*THE PRESENTED RESULTS REFER ONLY TO THE TESTED SAMPLE*

\* QUEDA TERMINANTEMENTE PROHIBIDA LA REPRODUCCION PARCIAL DE ESTE INFORME SIN PERMISO EXPRESO DE IDIADA.

*THE PARTIAL REPRODUCTION OF THIS REPORT WITHOUT THE PERMISSION OF IDIADA IS COMPLETELY FORBIDDEN*



No.	Equipment Name	Model Name	Serial No.	Manufacturer	Cal. Date (yy/mm/dd)	Next Cal. Date (yy/mm/dd)
<b>Radiated Immunity (Absorber Chamber Test)</b>						
1	Signal Generator	SMBV 100A	101251	Rohde & Schwarz	19/07/03	20/07/03
2	Power Meter	NRX	101195	Rohde & Schwarz	19/07/02	20/07/02
3	Average Power Sensor	NRP6A	102181	Rohde & Schwarz	19/07/02	20/07/02
4	Average Power Sensor	NRP6A	102182	Rohde & Schwarz	19/07/02	20/07/02
5	Wideband Power Sensor	NRP-Z81	105292	Rohde & Schwarz	19/07/02	20/07/02
6	Wideband Power Sensor	NRP-Z81	105293	Rohde & Schwarz	19/07/02	20/07/02
7	Power Amplifier	GN3500	2345	PRANA	N/A	N/A
8	Power Amplifier	MT1200	1107-1106	PRANA	N/A	N/A
9	Power Amplifier	SW420	2476	PRANA	N/A	N/A
10	Directional Coupler	C4080-726	118505	WERATONE	19/07/04	20/07/04
11	Directional Coupler	DC6580AM1	0351914	Amplifier Research	19/06/28	20/06/28
12	Directional Coupler	CHP272L-50F-50R/ITI	W053402z-02	ATM	19/07/04	20/07/04
13	Biconical Antenna	HBA-2030	131280	TDK	N/A	N/A
14	Log-Periodic Antenna	3148B	00219473	Schwarzbeck	N/A	N/A
15	Microwave Horn Antenna	ATH800M6GA	0352708	Amplifier Research	N/A	N/A
16	LISN	NNBM8124	586	Schwarzbeck	19/02/13	20/02/13
17	LISN	NNBM8124	587	Schwarzbeck	19/02/13	20/02/13

Lugar del ensayo / Place of test: DT&C (KOREA)

Fecha del ensayo / Date of test: 16/09/2019 a/to 24/09/2019



Kidong Lee  
INGENIERO DE HOMOLOGACIONES  
HOMOLOGATION ENGINEER

\* LOS RESULTADOS PRESENTADOS SE REFIEREN UNICAMENTE A LA MUESTRA ENSAYADA.  
THE PRESENTED RESULTS REFER ONLY TO THE TESTED SAMPLE

\* QUEDA TERMINANTEMENTE PROHIBIDA LA REPRODUCCION PARCIAL DE ESTE INFORME SIN PERMISO EXPRESO DE IDIADA.  
THE PARTIAL REPRODUCTION OF THIS REPORT WITHOUT THE PERMISSION OF IDIADA IS COMPLETELY FORBIDDEN

DOCUMENTACIÓN TÉCNICA /  
*TECHNICAL DOCUMENTATION*

ANNEX 2B

INFORMATION DOCUMENT  
FOR TYPE-APPROVAL OF AN ELECTRIC/ELECTRONIC SUB-ASSEMBLY  
WITH RESPECT TO ELECTROMAGNETIC COMPATIBILITY

Document No. : VXA-191007-00

1. Make (trade name of manufacturer) : VISION X or HAMMERHEAD or CF MOTO or OEX or CRX or ROADVISION or DURAVISION or PROLIGHT or NIGHTBREAKER or GENER8 or DULITE or SUPERVISION or SATURN or POLARIS or MAX LIGHT or GREAT WHITE or TWISTED THROTTLE or DENALI or THUNDER or TUSCANY or HIVIZ or BROW LIGHT or FIRETECH or INVINCIBLE or CUSTOM DYNAMICS or CD
2. Type : XPR-H6  
Variant(s) :  
  - 1) First two digits can be added for customized logo (ex) RA-
  - 2) Last any digits can be added for specific features such as housing color, accessory changes, package configuration, special beam configuration
  - 3) RA-XPR-H6S, RA-XPR-HS6S, RA-XPR-H6E, XPR-H6S, RA-XPR-6, XPR-6, RC-XPR6KIT, XPR-6S, GWB1063, GWB1064, XPR-H6E
- Commercial description(s) : XPR SERIES
3. Means of identification of type, if marked on the component/~~separate technical unit~~: (1) : Type name
  - 3.1. Location of that marking : Marked on the body
4. Name and address of manufacturer : VISION X ASIA Co., Ltd.  
23-7, Dongtansandan 9-gil, Dongtan-myeon, Hwaseong-si, Gyeonggi-do , Korea  
Name and address of authorized representative, if any: ---
5. In the case of components and separate technical units, location and method of affixing of the approval mark: Marked on the outer lens
6. Address(es) of assembly plant(s) : 23-7, Dongtansandan 9-gil, Dongtan-myeon, Hwaseong-si, Gyeonggi-do , Korea
7. This ESA shall be approved as a component / ~~STU~~ (2)
8. Any restrictions of use and conditions for fitting: See annexed drawing XPR-H6\_05
9. Electrical system rated voltage: DC 12V and 24V, ~~positive~~-/ negative (2) ground.

(1) If the means of identification of type contains characters not relevant to describe the component or separate technical unit types covered by this information document, such characters shall be represented in the documentation by the symbol "?" (e.g. ABC??123??).  
(2) Delete where not applicable.

Appendix 1:

Description of the ESA chosen to represent the type (electronic block diagram and list of main component constituting the ESA (e.g. make and type of microprocessor, crystal, etc.):

See annexed drawing XPR-H6\_03 and 04

Appendix 2:

Relevant test report(s) supplied by the manufacturer from a test laboratory accredited to ISO 17025 and recognized by the Approval Authority for the purpose of drawing up the type approval certificate:

KR19100101

This model information document consists of pages 1 and 2 with 11 pages of enclosures.

LIST OF ANNEXED

Drawing No.	Descriptions	Sheet
XPR-H6_01	Front view of LED bar light	1
XPR-H6_02	Rear view of LED bar light	1
XPR-H6_03	Block diagram	1
XPR-H6_04	Circuit diagram	2
XPR-H6_05	Conditions for fitting	6

Date: 07/10/2019  
Place: KOREA  
Written by: Geun Woong Kim

Drawing no. : XPR-H6\_01  
Type : XPR-H6  
Title : Front view of LED bar light



Type approval mark

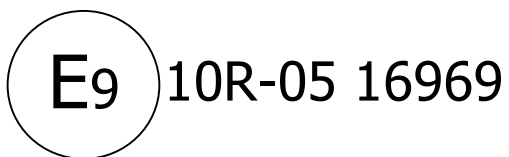

Drawing no. : XPR-H6\_02  
Type : XPR-H6  
Title : Rear view of LED bar light



Drawing no. : XPR-H6\_03  
Type : XPR-H6  
Title : Block diagram

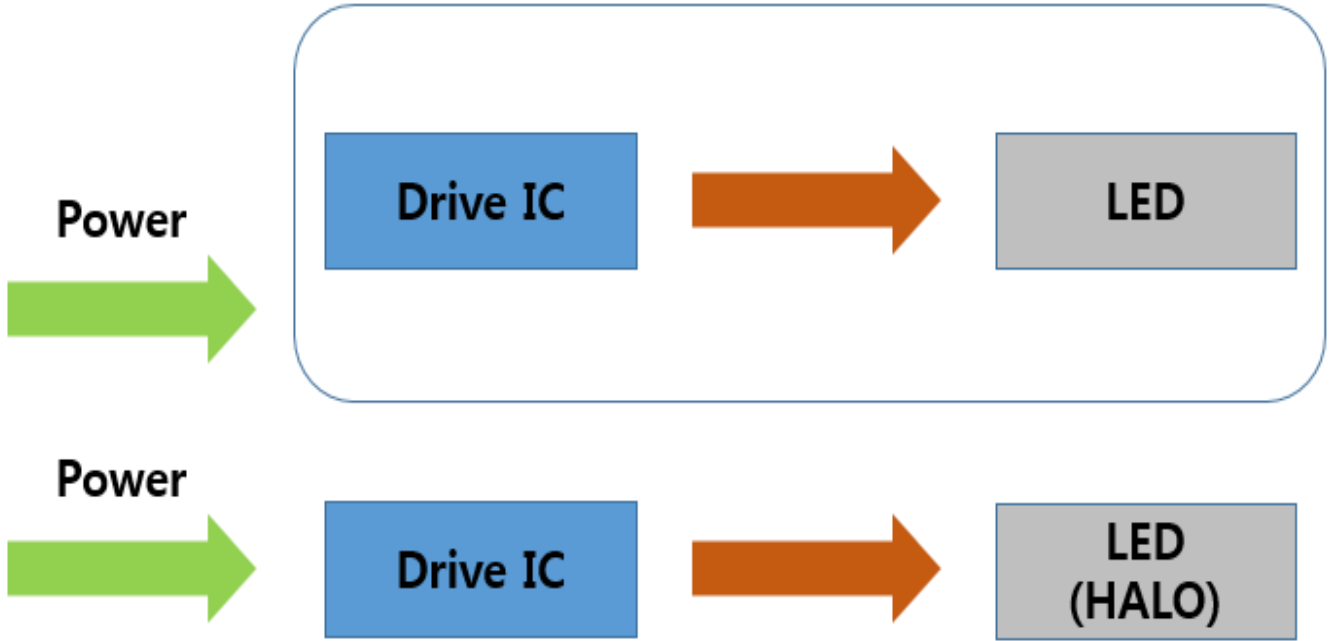



Drawing no. : XPR-H6\_04  
Type : XPR-H6  
Title : Circuit diagram

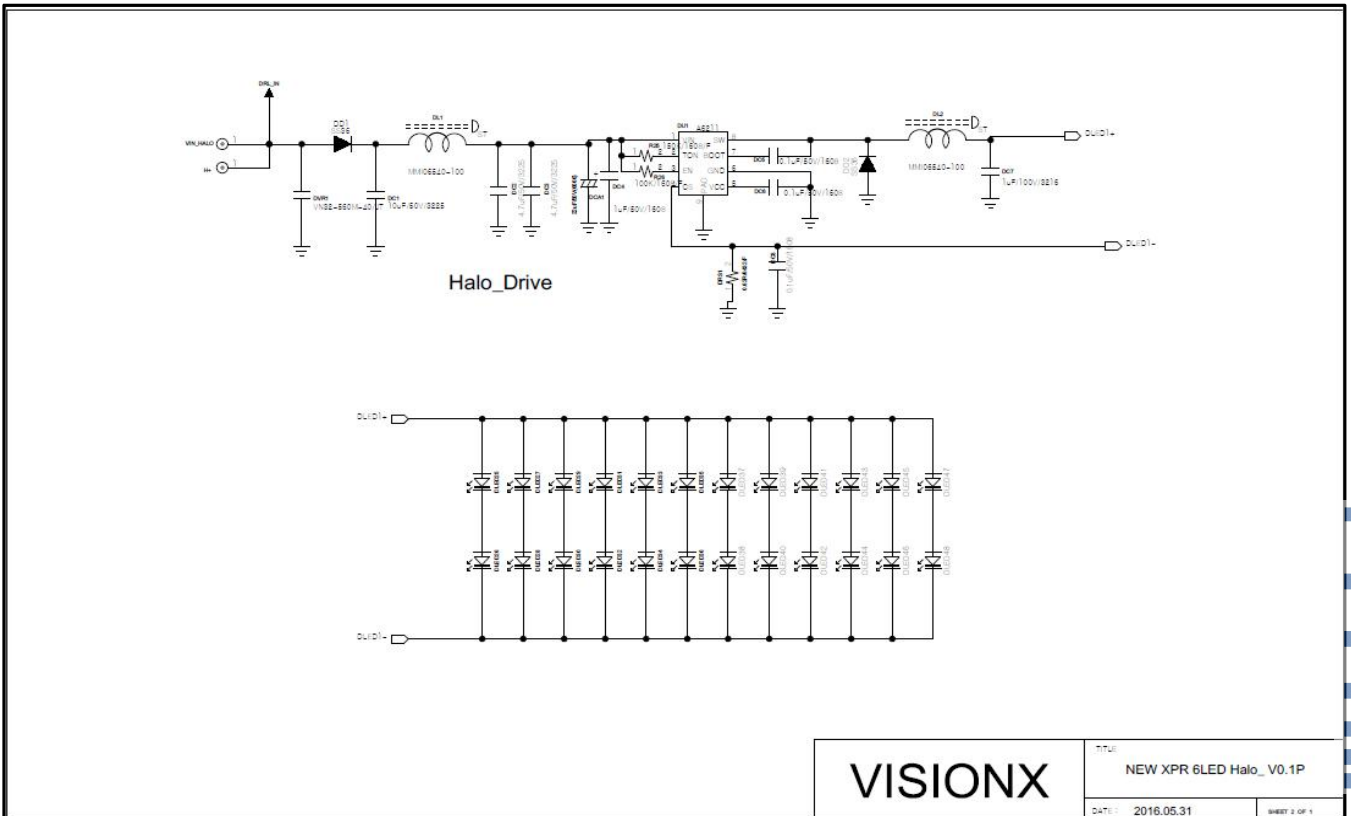
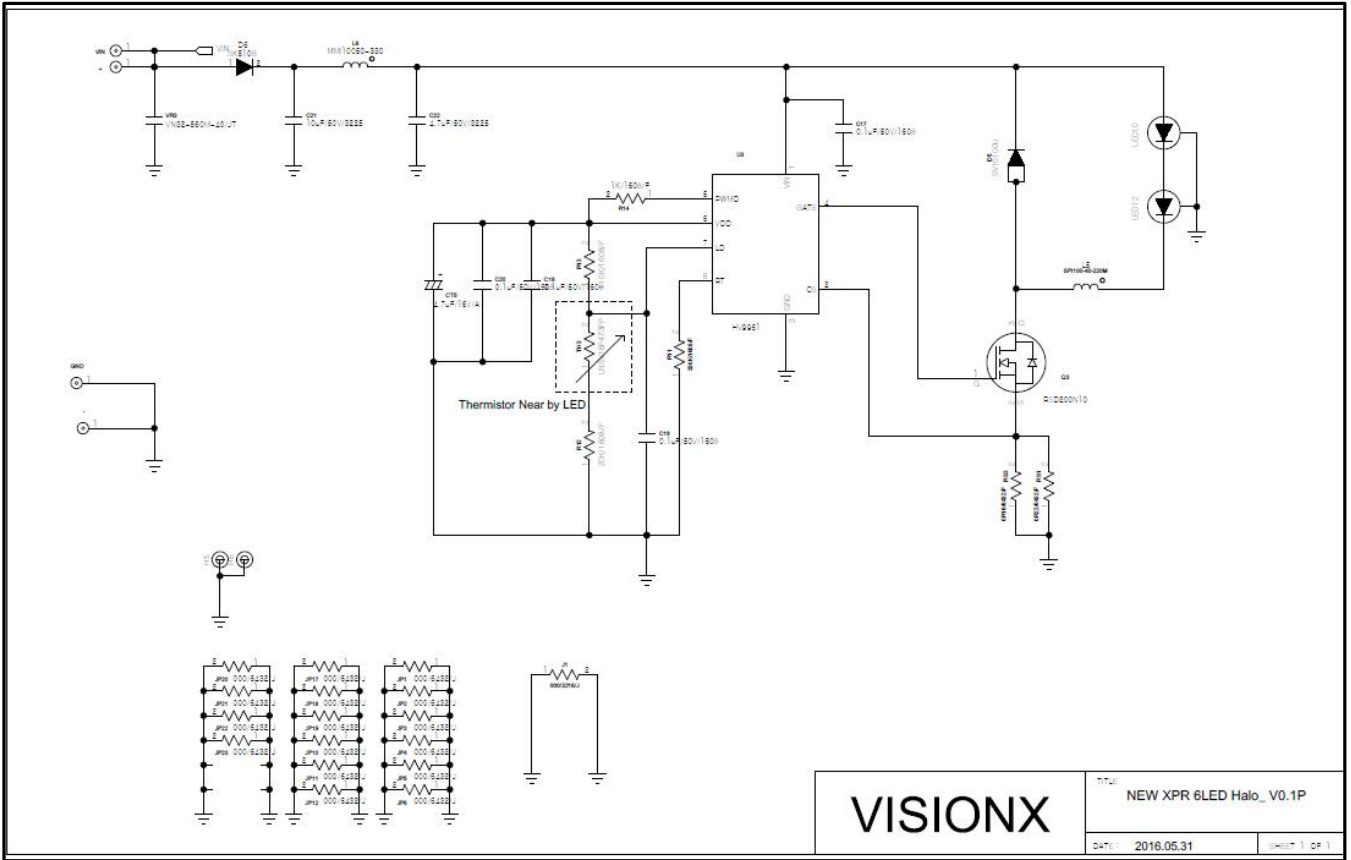

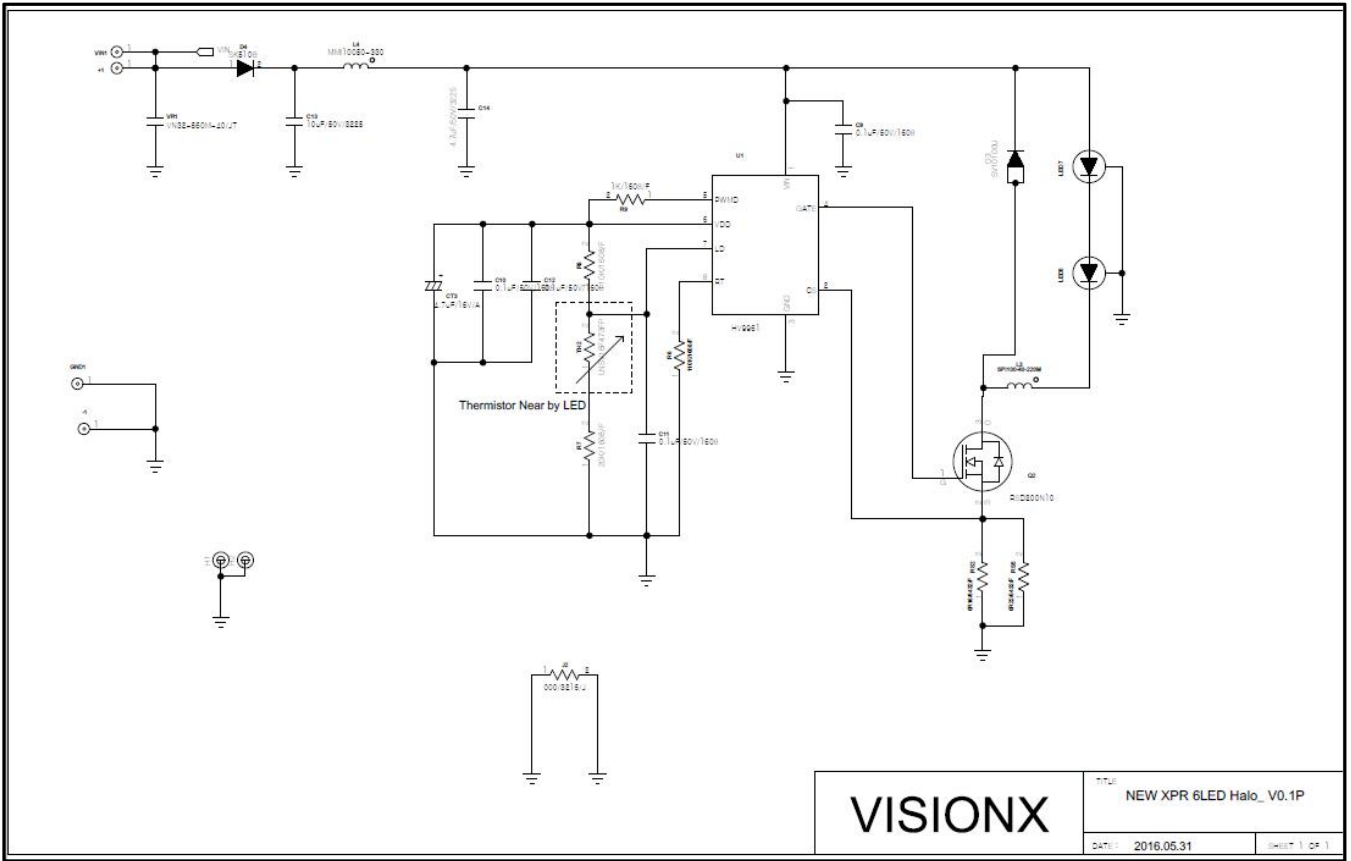

Drawing no. : XPR-H6\_05  
Type : XPR-H6  
Title : Conditions for fitting

## VISION X



### About The XPR Halo LED Light Bar:



#### **FEATURES**

1. Smooth white Halo.
2. IRIS reflector technology for ultimate distance.
3. Dual mounting options; end cap and mounting feet.

#### **XPR-HS LED LIGHT BAR SPECIFICATIONS**

1. Warranty : Extended
2. Amp Draw : 2.5A - 22.5A @ 12V DC
3. Input Voltage : 9-32V DC
4. Beam Patterns : Spot with Halo
5. LED Lifespan : 50,000 Hours

#### **PREPARATION**

1. We recommend completely reading instructions before installing.
2. Consult your local state regulatory agency regarding the use of LED lighting.
3. The placement of LED lighting should not restrict airflow to the radiator or block head lamps, turn signals, or parking lights.

#### **MAINTENANCE**

1. All Vision X models have been designed for maintenance free use. In the case an LED lamp or other part replacement is needed please contact your authorized service center.

# XPR HALO LED LIGHT



## INSTALLATION IMAGES



## WING INSTALLATION IMAGE

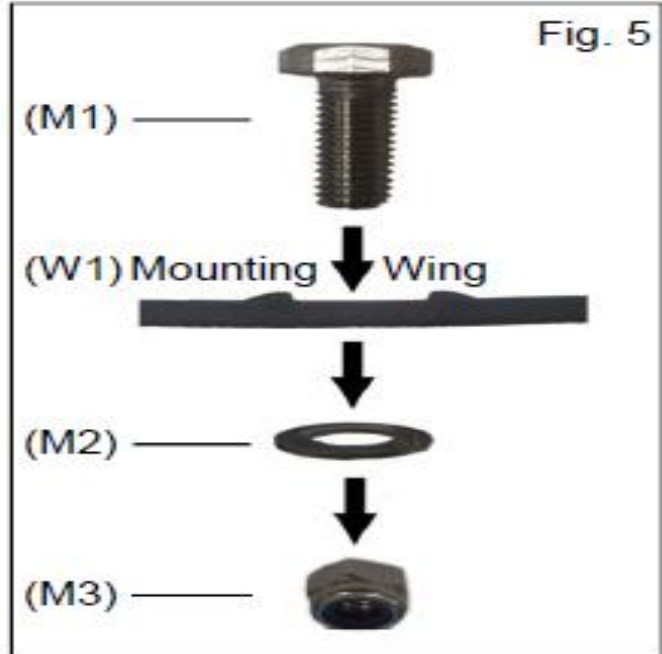

## LIGHT ANGLE ADJUSTMENT

1. Use the provided 5mm Allen wrench Part (A1) to loosen both Allen bolts on each side the light bar. Once desired angle is achieved, tighten the bolts. See [Figure 4]
2. A good reference point is at 20 ft; the top of the beam should be 3" down from center of light (with the light bar at dead center). Tighten light and enjoy.

**TIP:** Vision X recommends the use of liquid thread-locker, or Loctite, to ensure that every bolt and nut are safely secured.

# VISION X



**WARNING: Bolts, Nuts, and Washers are Stainless Steel. DO NOT USE Pneumatic or Electric Tools to Tighten and Loosen. The Hardware Will Permanently Lock Together.**

## **MOUNTING INSTALLATION INSTRUCTION FOR WINGS (END CAPS)**

1. Insert two (2) rubber grommets Part (G1) on each side of the LED bar over the appropriate threaded bolt holes. See [Figure 1]
2. Place the mounting wings Part (W1) over the rubber grommets (G1) and insert the wing bolts Part (B1). See [Figure 2]
3. Use a phillips screwdriver to tighten the wing bolts (B1), starting with the top bolt first. See [Figure 2]
4. Place the light bar on the location where it will be mounted.
5. Determine where the M8 bolt Part (M1) will be placed for each wing, and mark the bolt location for each side.
6. Drill a hole for the M8 bolt using a 6.8mm drill bit.
7. Line the light bar wings over the drilled hole and slide the M8 bolt (M1) through.
8. Slide the washer Part (M2) on the opposite side of the drilled hole followed by the nut Part (M3), and screw until secured. See [Figure 5]

## **MOUNTING INSTALLATION INSTRUCTION FOR FEET**

1. Set the light bar in the location you plan to mount. Mark each end of the light bar and measure the length.
2. Depending on the length of your light bar, will determine the number of mounting feet Part (F1) included in the packaging. These feet fit into grooves on the back of the light bar. See [Figure 3]
3. Place each mounting feet (F1) (with bolt head pointing into light bar) into the feet grooves on the back of the light bar.
4. Mark the location of each mounting feet (F1) on your vehicle. Drill holes for each. The feet can slide inside the grooves, letting you fine tune the location.
5. Line up the feet (F1) with the previously drilled holes and place the light bar onto your vehicle.
6. Securely tighten the nut to the mounting feet bolt.

# XPR HALO LED LIGHT



**1** XPR Halo



**LIGHT** Qty: 1

**2** Single Light Harness



**WIRING** Qty: 1

**3** Allen Key [5mm]



**PART (A1)** Qty: 1

**4** Wing Mounts (Side Mount)



**PART (W1)** Qty: 2

**5** Wing Bolt/ Washer



**PART (B1)** Qty: 4

**6** Rubber Grommet



**PART (G1)** Qty: 4

**7** Hex Head Bolt [M8]



**PART (M1)** Qty: 2

**8** Washer [M8]



**PART (M2)** Qty: 2

**9** Nylock Nut [M8]



**PART (M3)** Qty: 2

**10** Mounting Feet



**PART (F1)** Table 1

**Table 1:**  
**MOUNTING FEET BY NUMBER OF LEDS**

LED	3LED	6LED	9LED	12LED	15LED	18LED	21LED	24LED	27LED
# of Feet	2	2	3	4	5	5	6	6	7

## VISION X



### WIRING INSTALLATION INSTRUCTION

1. Find a suitable place to mount Relay Part (R1) leaving enough room for Power & Ground wires Part (W1 & W2) to reach the battery & the Deutsch connector Part (C1) to reach the Light. Mount Relay.
2. Run Power wire (W1) & Ground wire (W2) to the battery. Connect the Power wire (W1) to the Positive (+) battery terminal and connect the Ground wire (W2) to the Negative (-) battery terminal.
3. Run the Deutsch connector wire (C1) to the light and plug in.
4. To connect the Halo wire Part (H1) tap the yellow wire to an existing power source or on its own auxiliary switch.
5. Disconnect the Switch Part (S1) at the white Plug Part (P1) and run the wire through the vehicles fire wall to desired mounting location inside the Cab [using a factory rubber or plastic grommet is suggested].
6. Drill the hole to the required size for the Switch (S1) and mount to desired position.
7. Reconnect the Switch (S1) to the Harness.
8. Test Light.

### MANUFACTURER RECOMMENDATION

For those unfamiliar with electrical wiring on vehicles, Vision X recommends that all LED Lighting products are professionally installed.

**TIP:** For complete application guide see website

# XPR HALO LED LIGHT



## WIRING DIAGRAM:

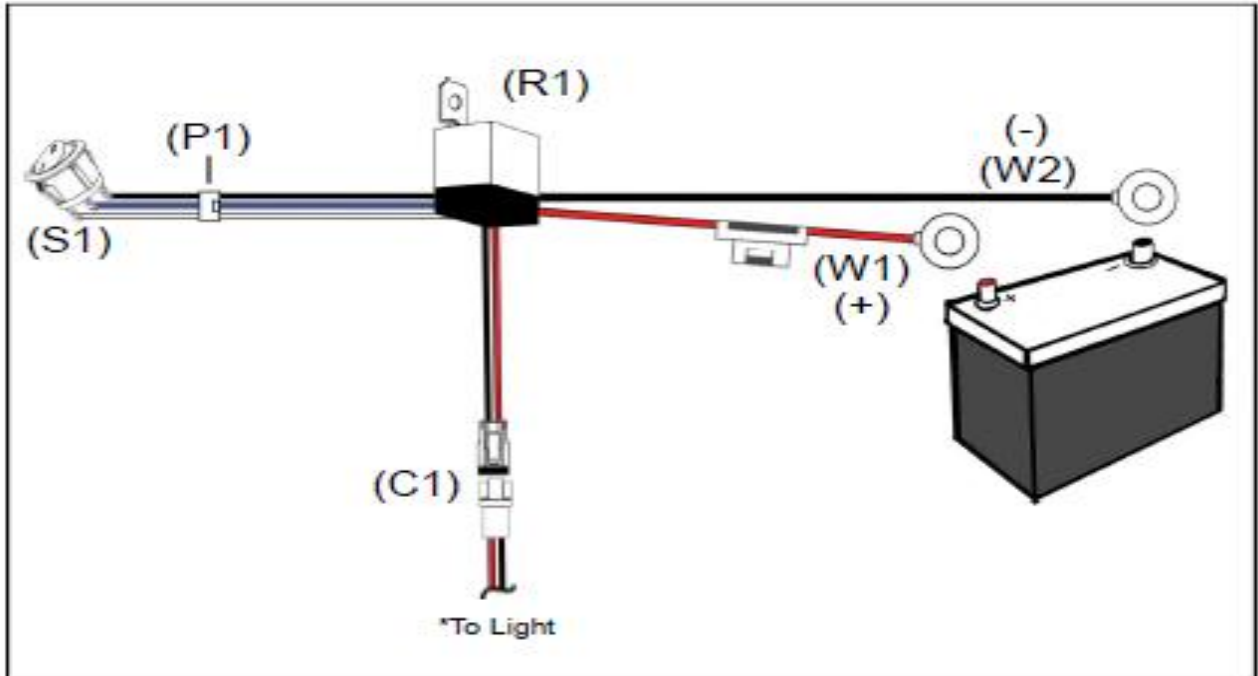

## HALO WIRE:



## COMPONENTS KEY

- Part (R1) Relay
- Part (W1) Power Wire for Relay Coil
  - a. 9-32V DC Positive (+) Input Wire
- Part (W2) Ground Wire for Relay Coil
  - a. 9-32V DC Negative (-) Input Wire
- Parts (C1) Deutsch Connector for Light
  - a. Attached to 9-32V DC Positive (+) Power Wires
- Part (H1) Halo Wire
- Part (S1) Switch
- Part (P1) Switch Plug