

/W Crafter / MAN TGE 2017-

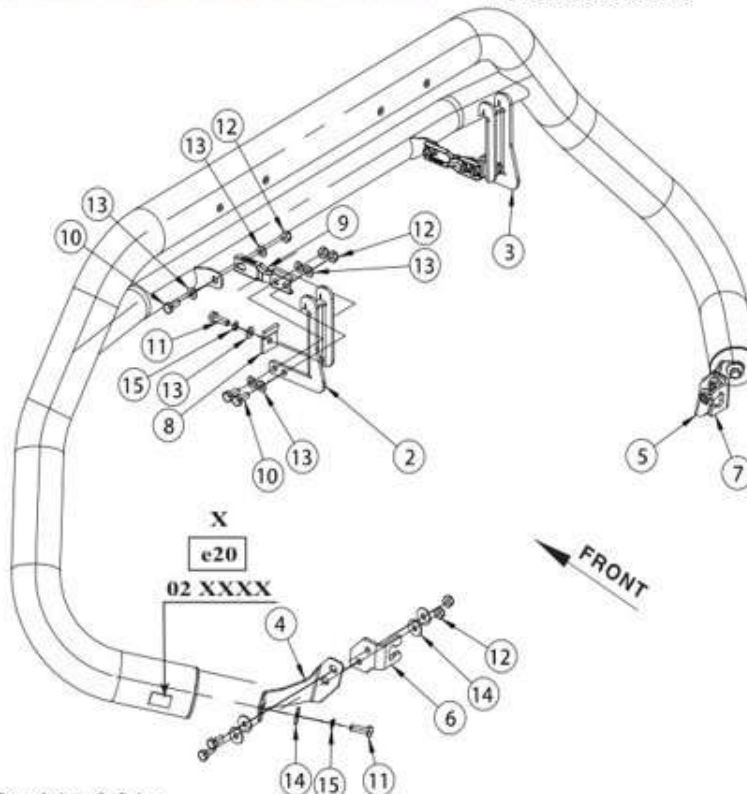

1. Eurobar / eurobar / евробар / eurobar
2. Kronstein / bracket / кронштейн / Konsole
3. Kronstein / bracket / кронштейн / Konsole
4. Kronstein / bracket / кронштейн / Konsole
5. Kronstein / bracket / кронштейн / Konsole
6. Kronstein / bracket / кронштейн / Konsole
7. Kronstein / bracket / кронштейн / Konsole
8. Plaat / plate / пластина / Platte
9. Kompensator / compensator / компенсатор /
Kompensator nr. 2
10. Polt / bolt / болт / Bolzen M8x20
11. Polt / bolt / болт / Bolzen M8x25
12. Mutter / nut / гайка / Mutter M8
13. Seib / washer / шайба / Scheibe 8,4x16x1,6.
14. Seib / washer / шайба / Scheibe 8,4x24x2
15. Vedruseib / spring washer / пружинная шайба /
Federnscheibe A8



M8 - 25N



aal / Weight / Масса / Gewicht: 8,3 kg

laksim. lubatud laternapaigaldise kaal / Max. weight of assembly of extralights / Максимально допустимая масса
дополнительных фар / maximale zulässige Gewicht der Zusatzscheinwerfer: 2,6 kg

aigaldusaeg / Time of mounting / Время установки / Einbauzeit: 45 min

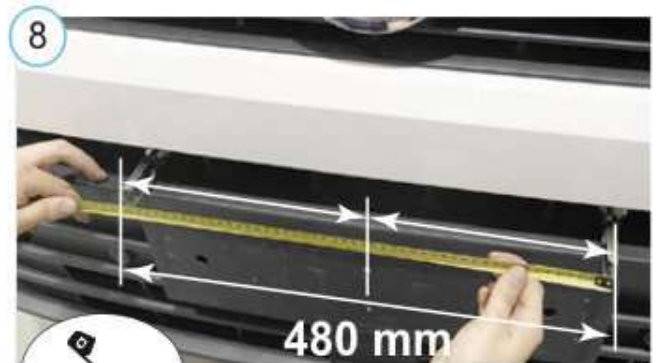
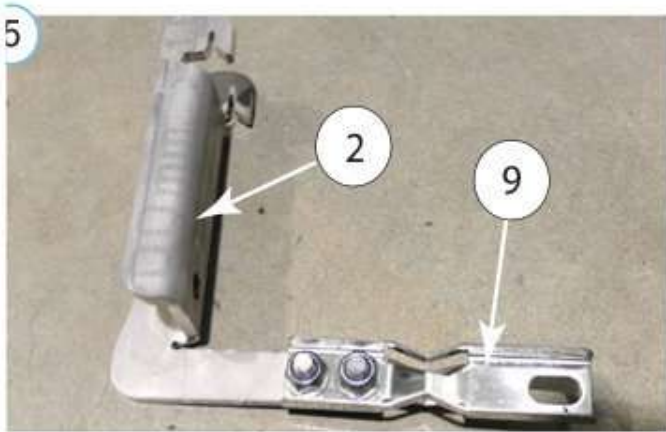
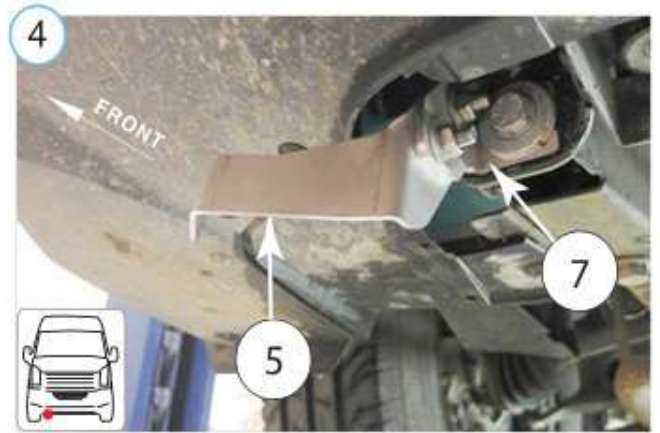
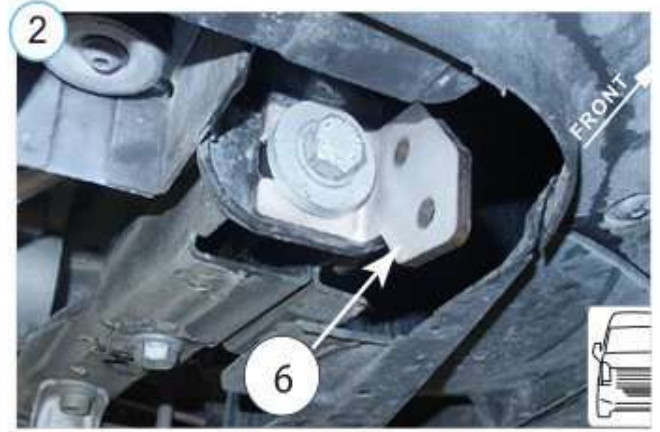
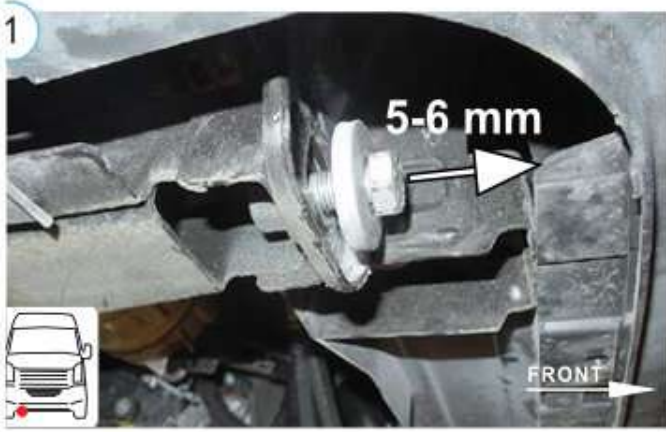

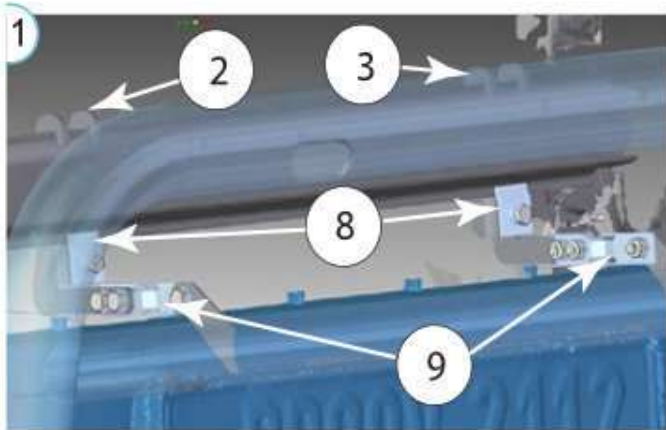
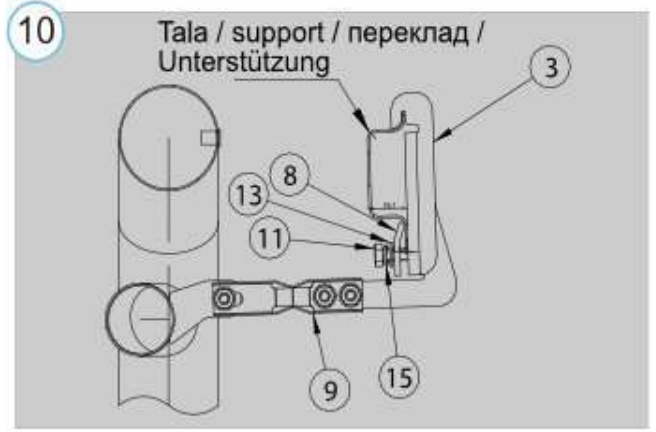

3

10 000 km

Nm

1	2	3	4	5	6	7
8	9				13	14
15	16				20	21
22	23				27	28
29	30					

1x

